

Page 1 : Overview
Page 2 : Computer System
Page 3 : Local File Systems
Page 4 : Remote FS/File Export
Page 5 : File Import
Page 6 : FileSystemService
Page 7 : Operating System
Page 8 : Processing and Job Queues
Page 9 : Jobs 2
Page 10 : Boot Service
Page 11 : Time
Page 12 : UNIX
Page 13 : System Resources
Page 14 : Message Logs
Page 15 : Logs 2
Page 16 : Diagnostics 1
Page 17 : Diagnostics 2
Page 18 : Help
Page 19 : Virtualization
Page 20 – Watchdog
Page 21 : Association Hierarchy
Page 22 : Dependency Hierarchy
Page 23 : Dependency Hierarchy (2)
Page 24 : Aggregation Hierarchy

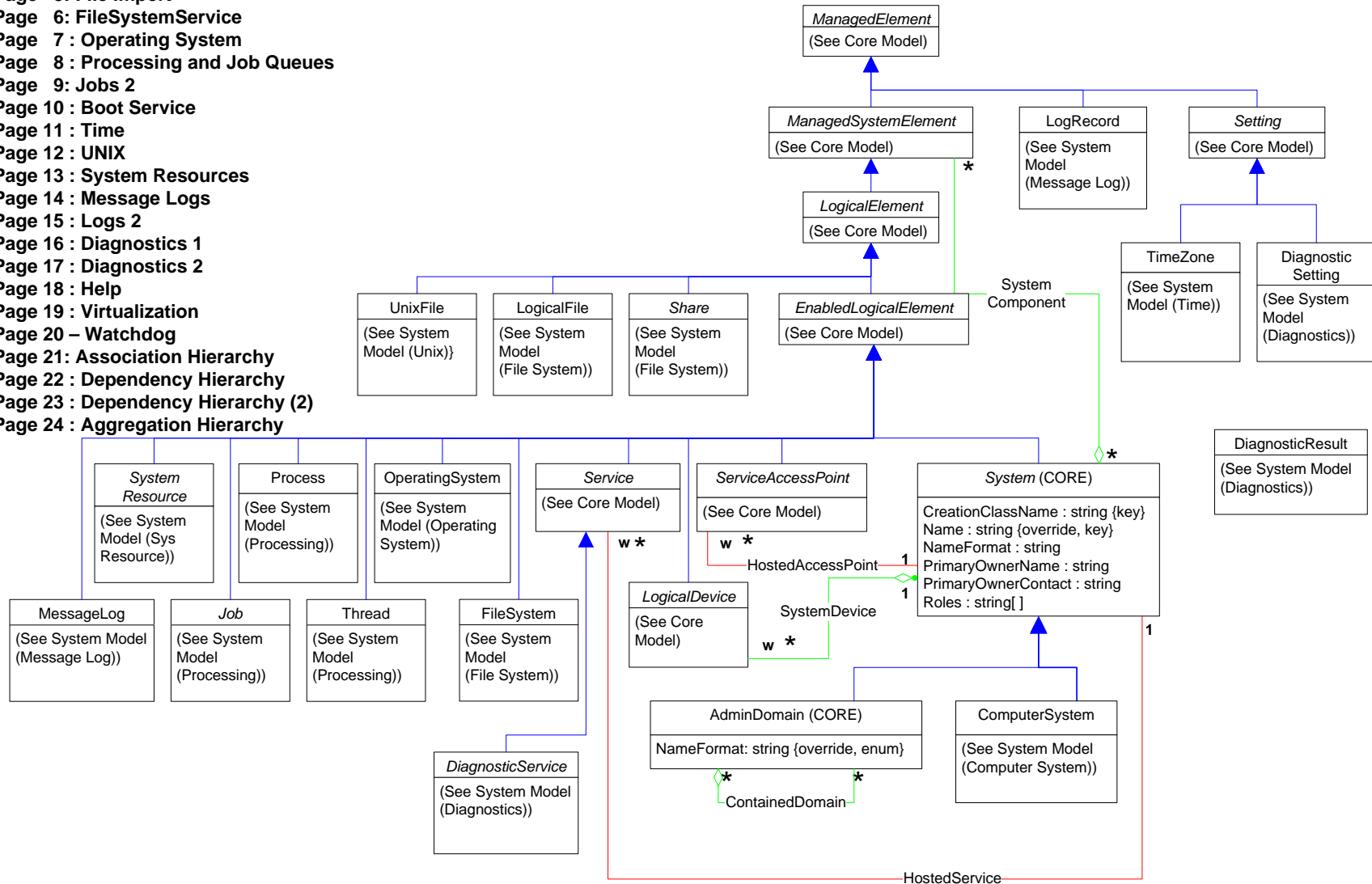

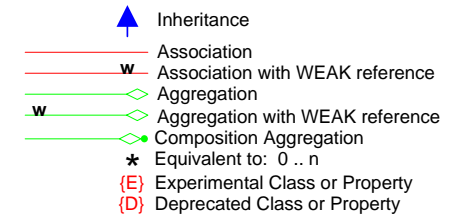

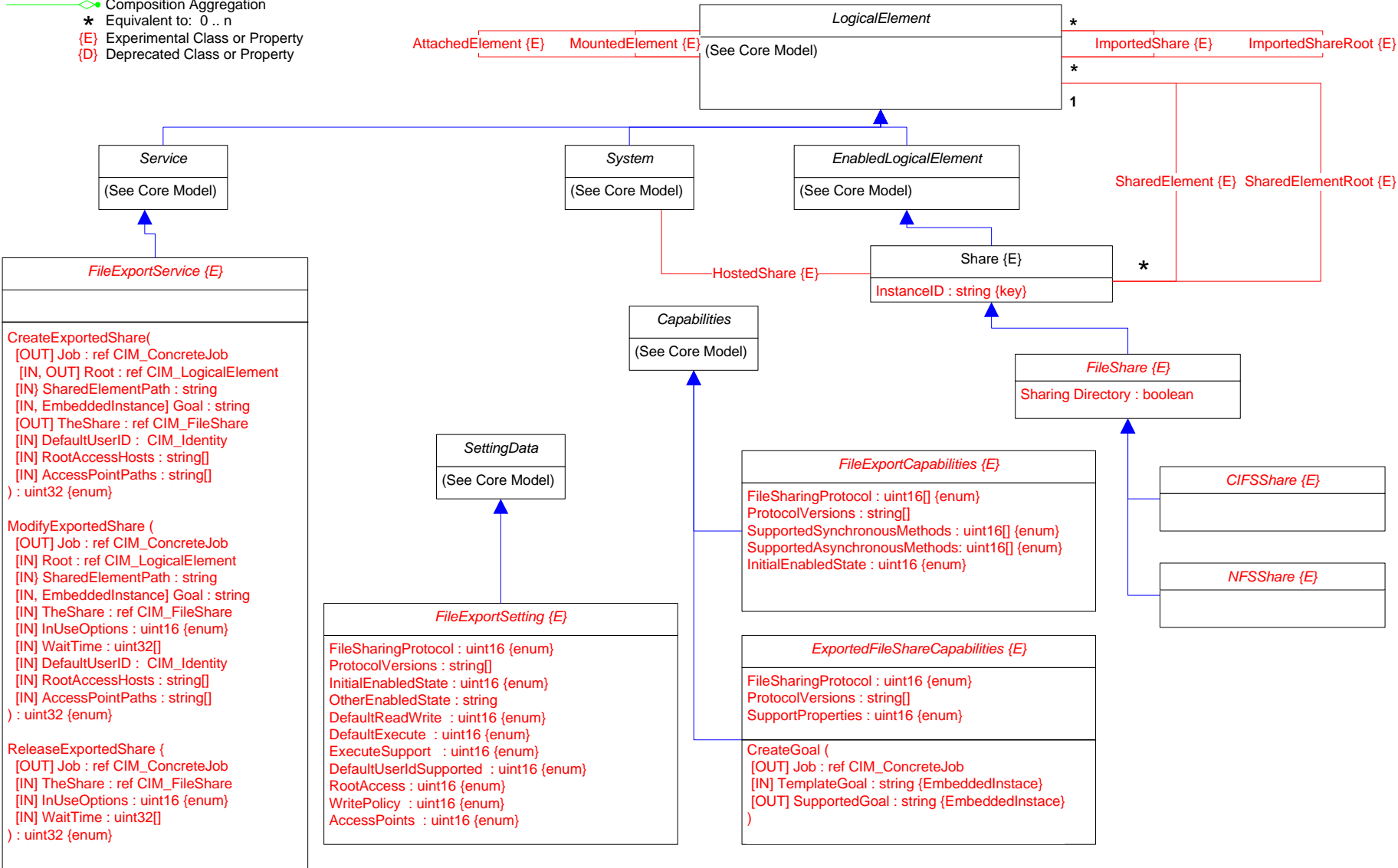





Page 4 : Remote File Systems / File Export Service

- ▲ Inheritance
- Association
- w Association with WEAK reference
- ◇ Aggregation
- w Aggregation with WEAK reference
- ◊ Composition Aggregation
- * Equivalent to: 0..n
- {E} Experimental Class or Property
- {D} Deprecated Class or Property







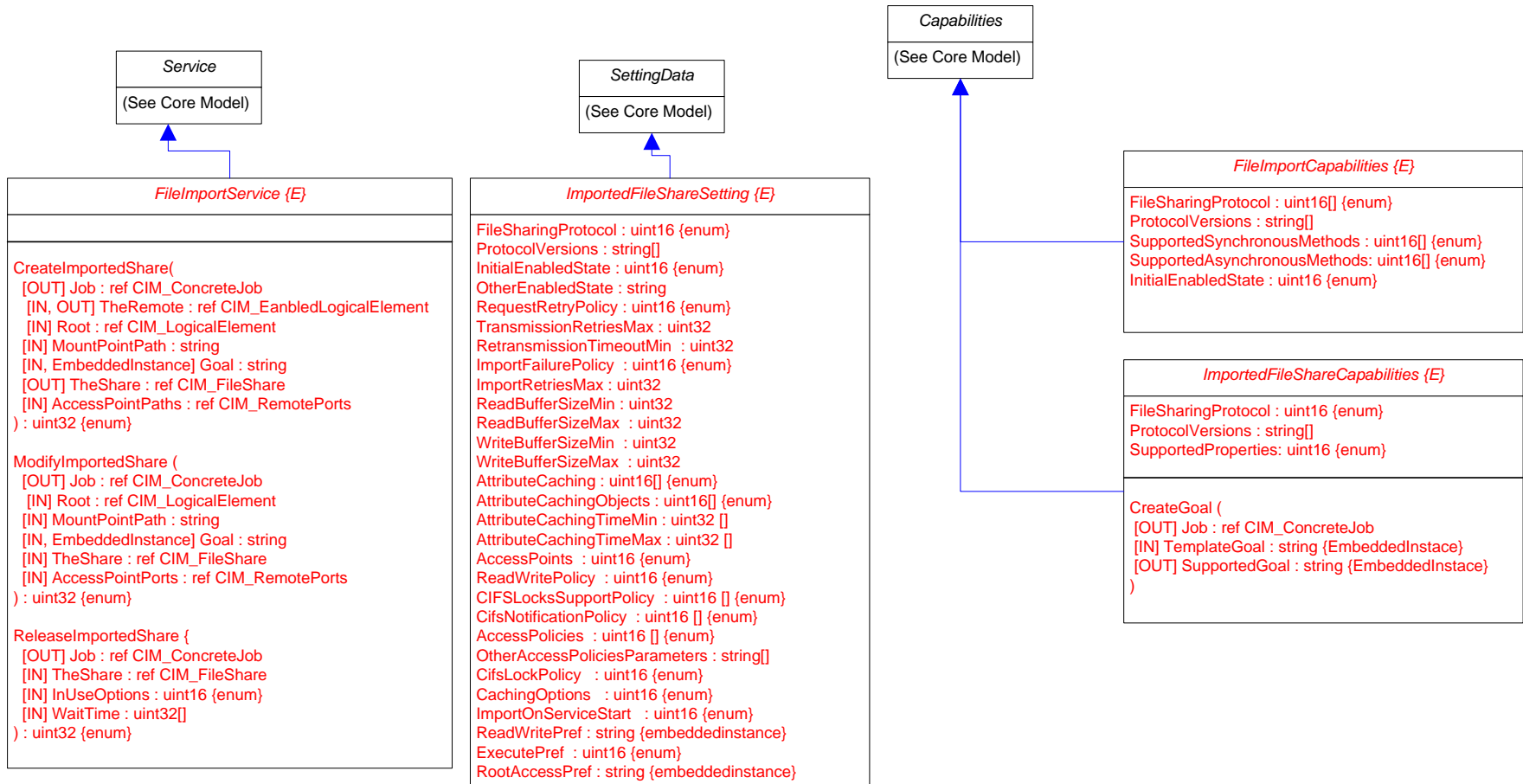



Page 5 : File Import Service

-  Inheritance
-  Association
-  Association with WEAK reference
-  Aggregation
-  Aggregation with WEAK reference
-  Composition Aggregation
-  Equivalent to: 0..n
-  {E} Experimental Class or Property
-  {D} Deprecated Class or Property







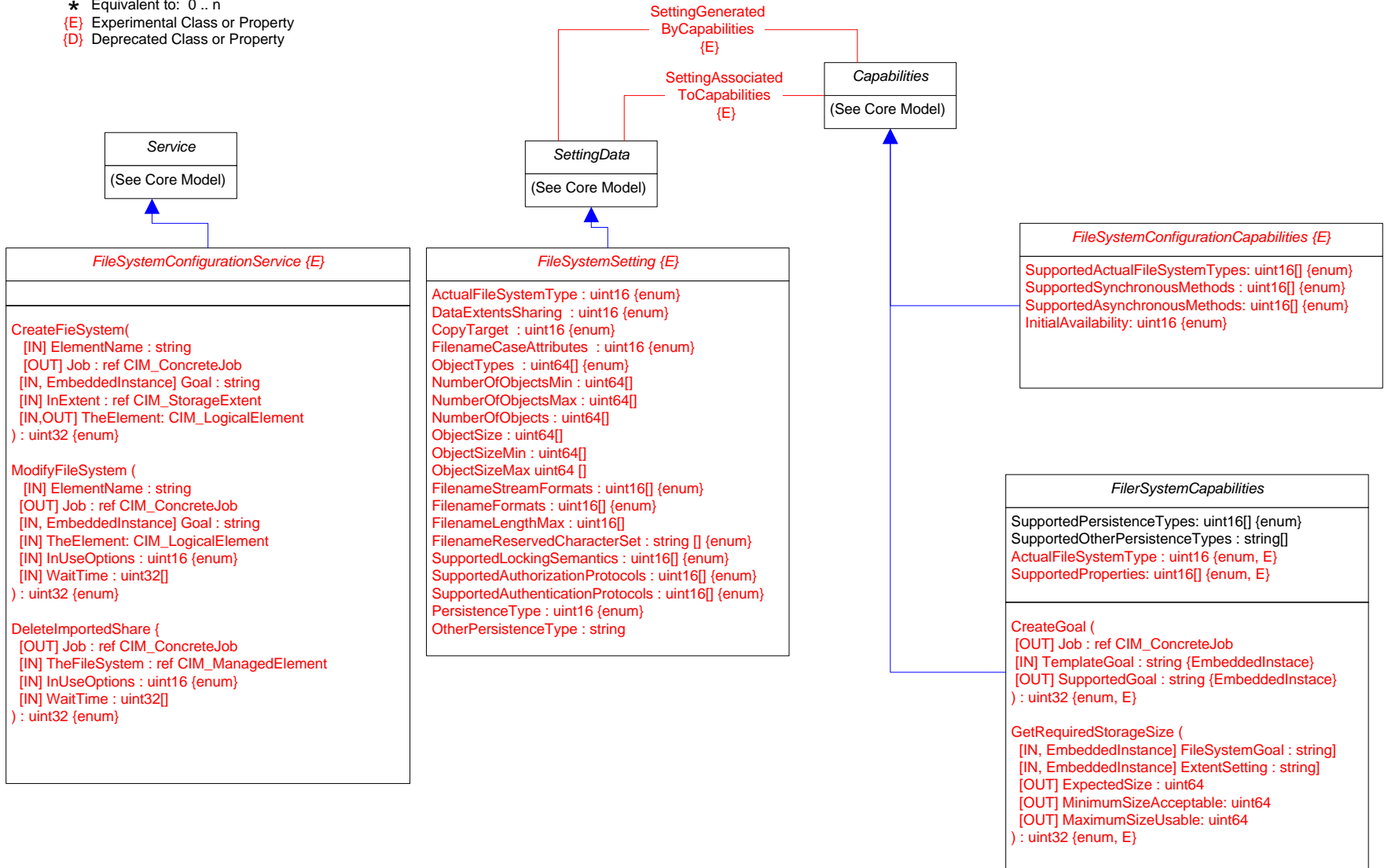



Page 6 : File Import Service

-  Inheritance
-  Association
-  Association with WEAK reference
-  Aggregation
-  Aggregation with WEAK reference
-  Composition Aggregation
-  Equivalent to: 0..n
-  Experimental Class or Property
-  Deprecated Class or Property







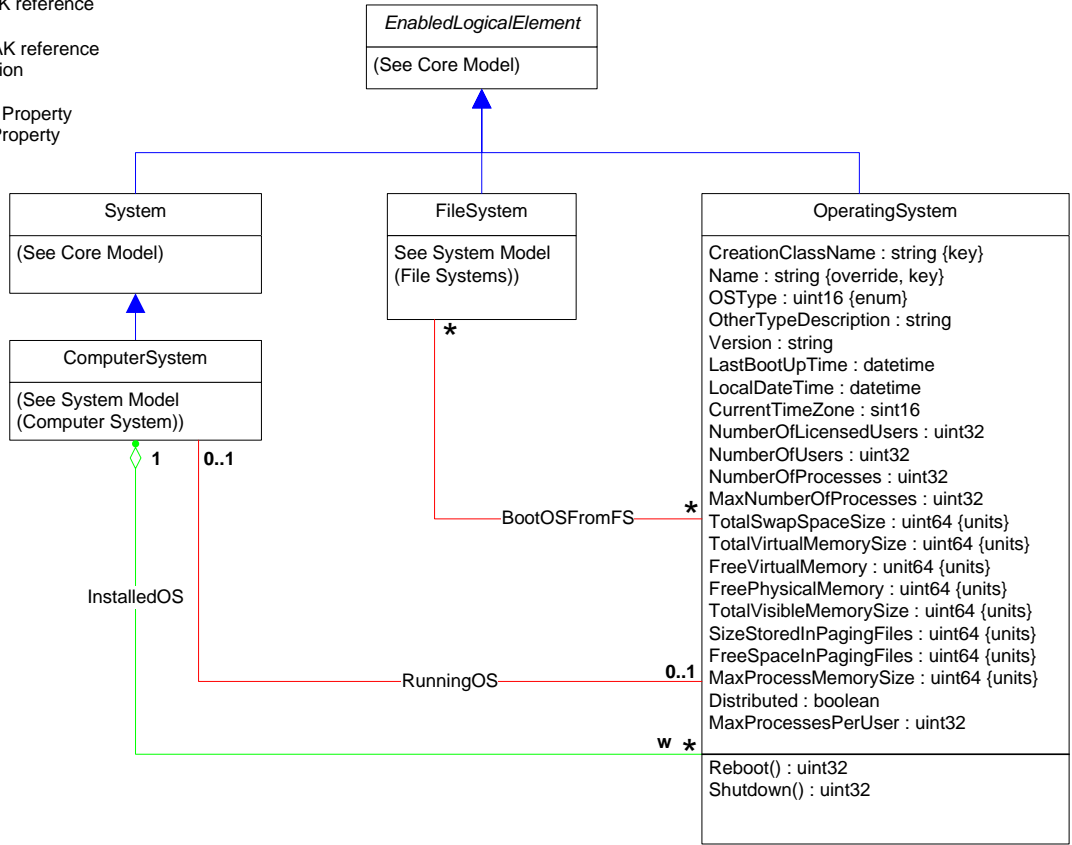

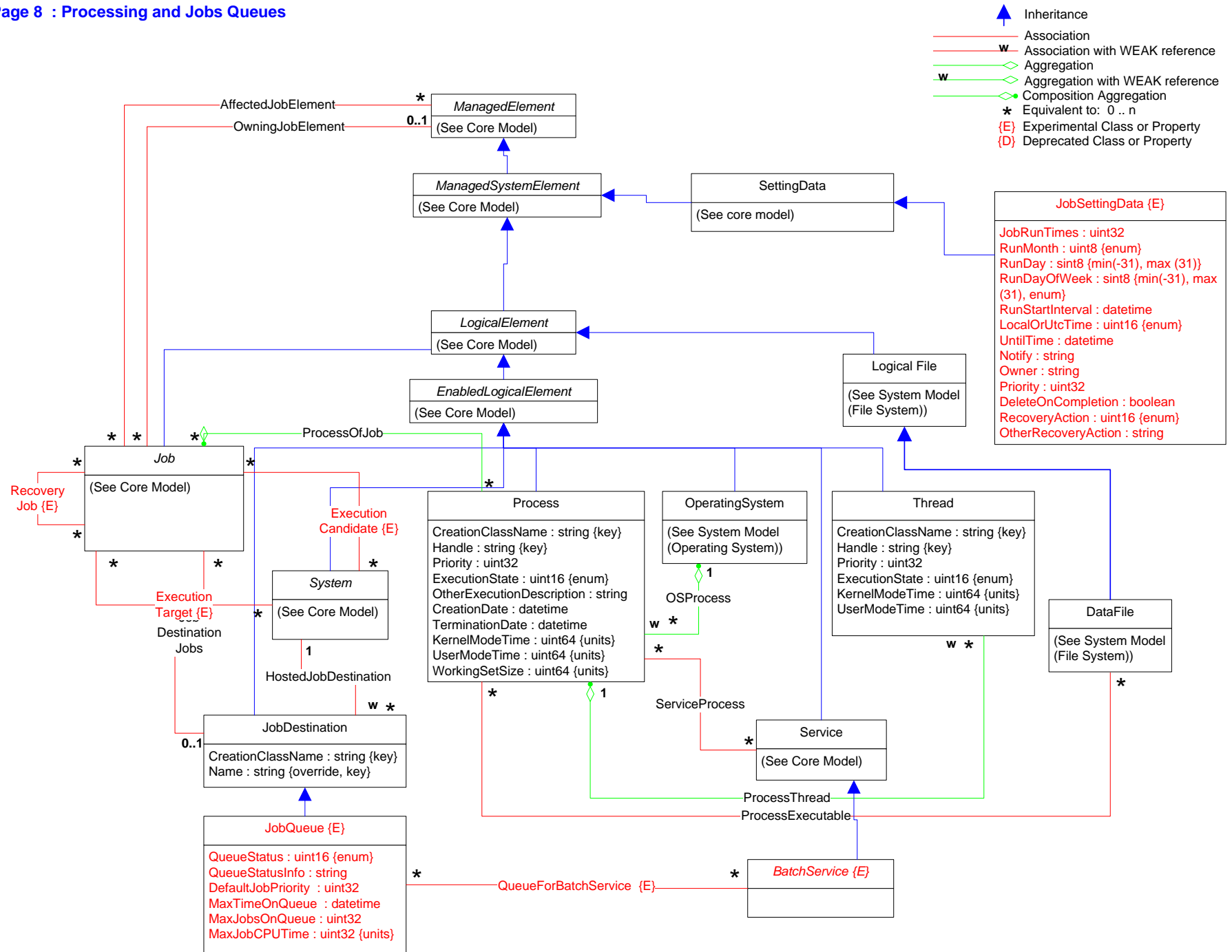

Page 7 : Operating System

-  Inheritance
-  Association
-  Association with WEAK reference
-  Aggregation
-  Aggregation with WEAK reference
-  Composition Aggregation
-  Equivalent to: 0 .. n
-  Experimental Class or Property
-  Deprecated Class or Property





-  Inheritance
-  Association
-  Association with WEAK reference
-  Aggregation
-  Aggregation with WEAK reference
-  Composition Aggregation
-  Equivalent to: 0..n
-  Experimental Class or Property
-  Deprecated Class or Property

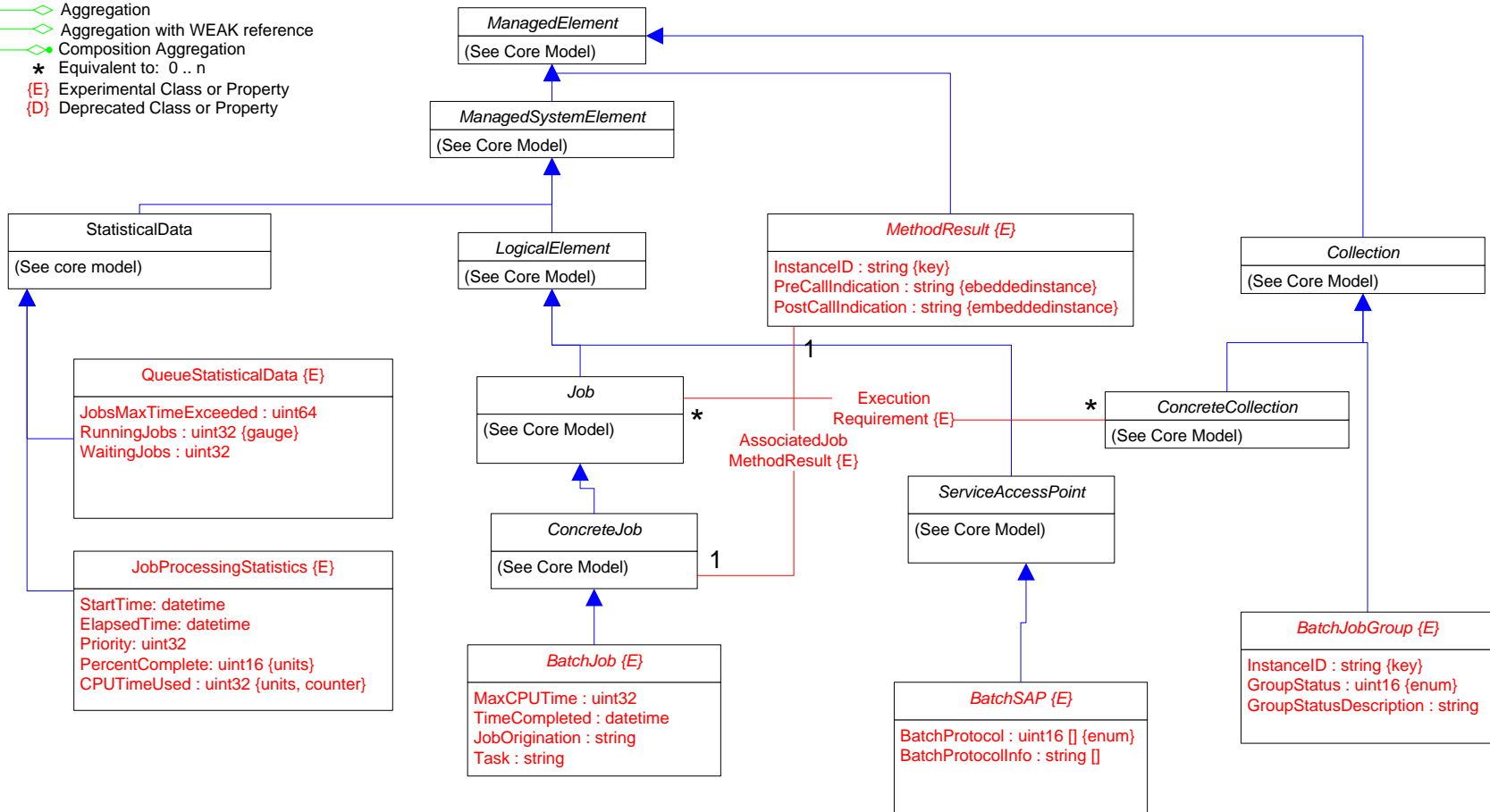

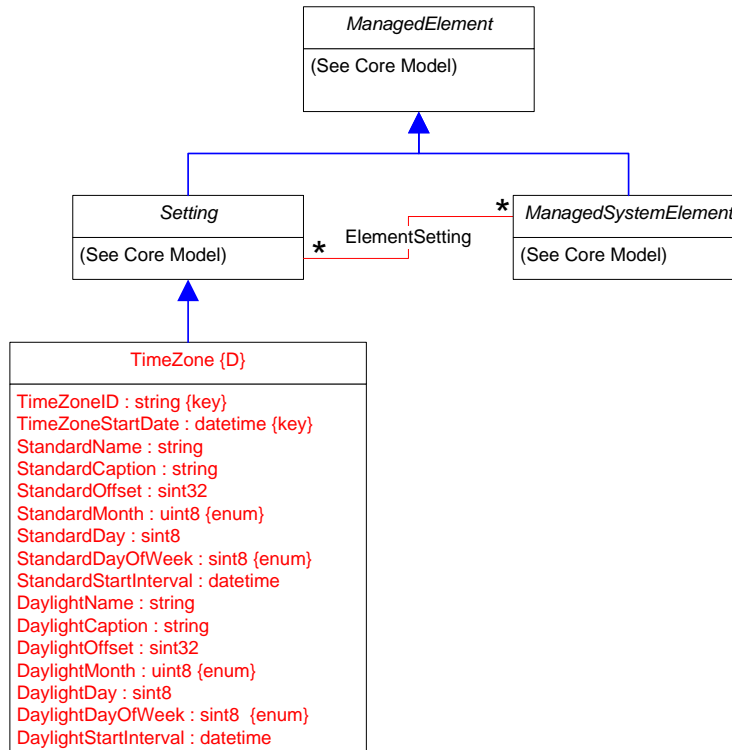
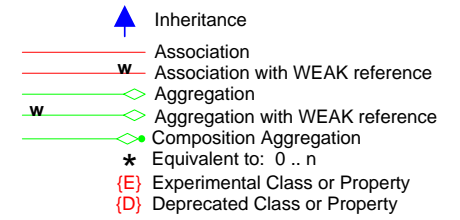

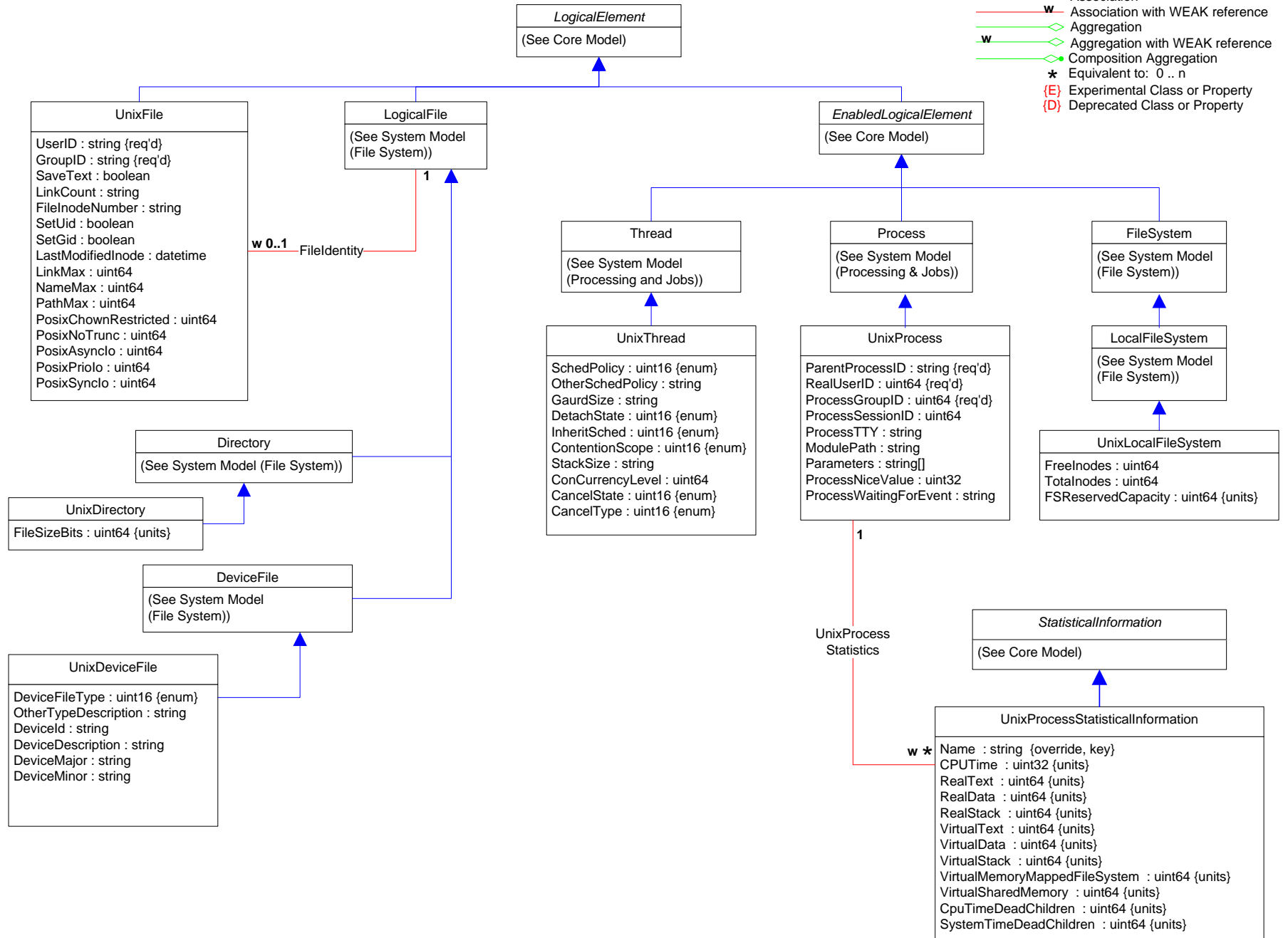
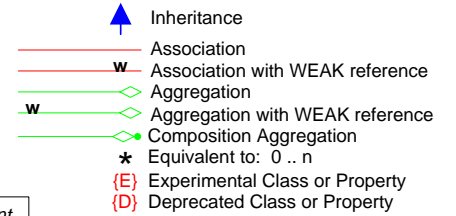

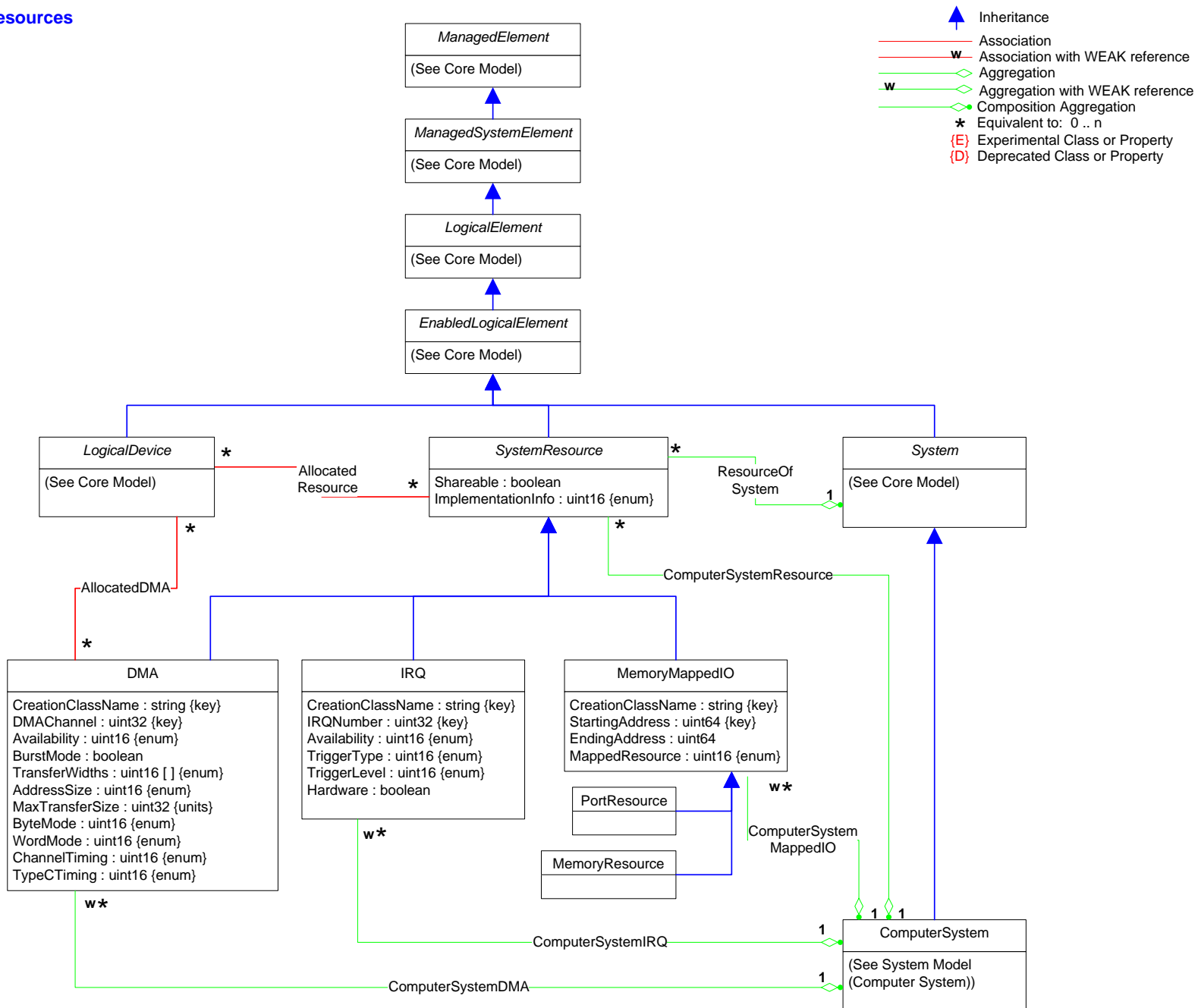

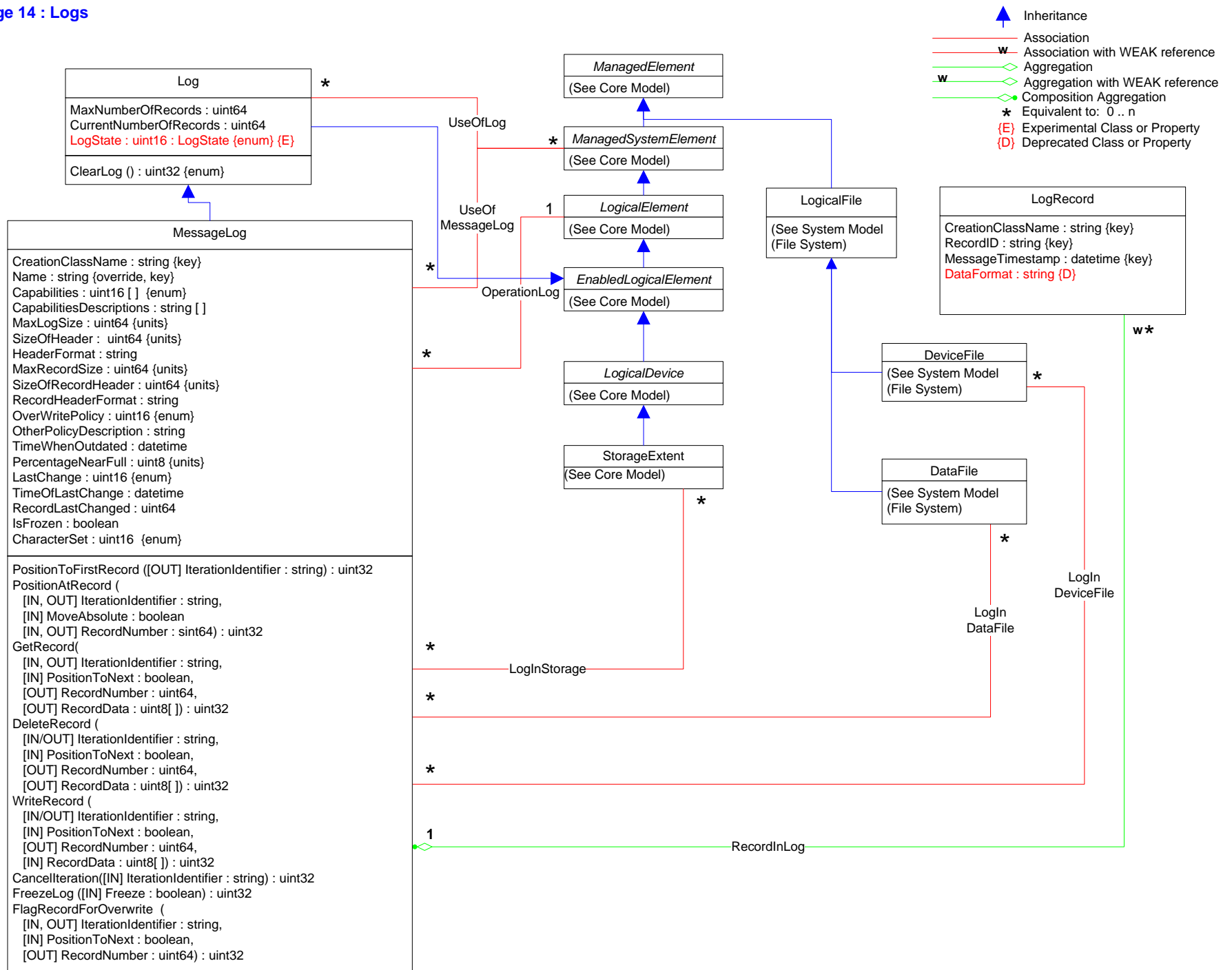

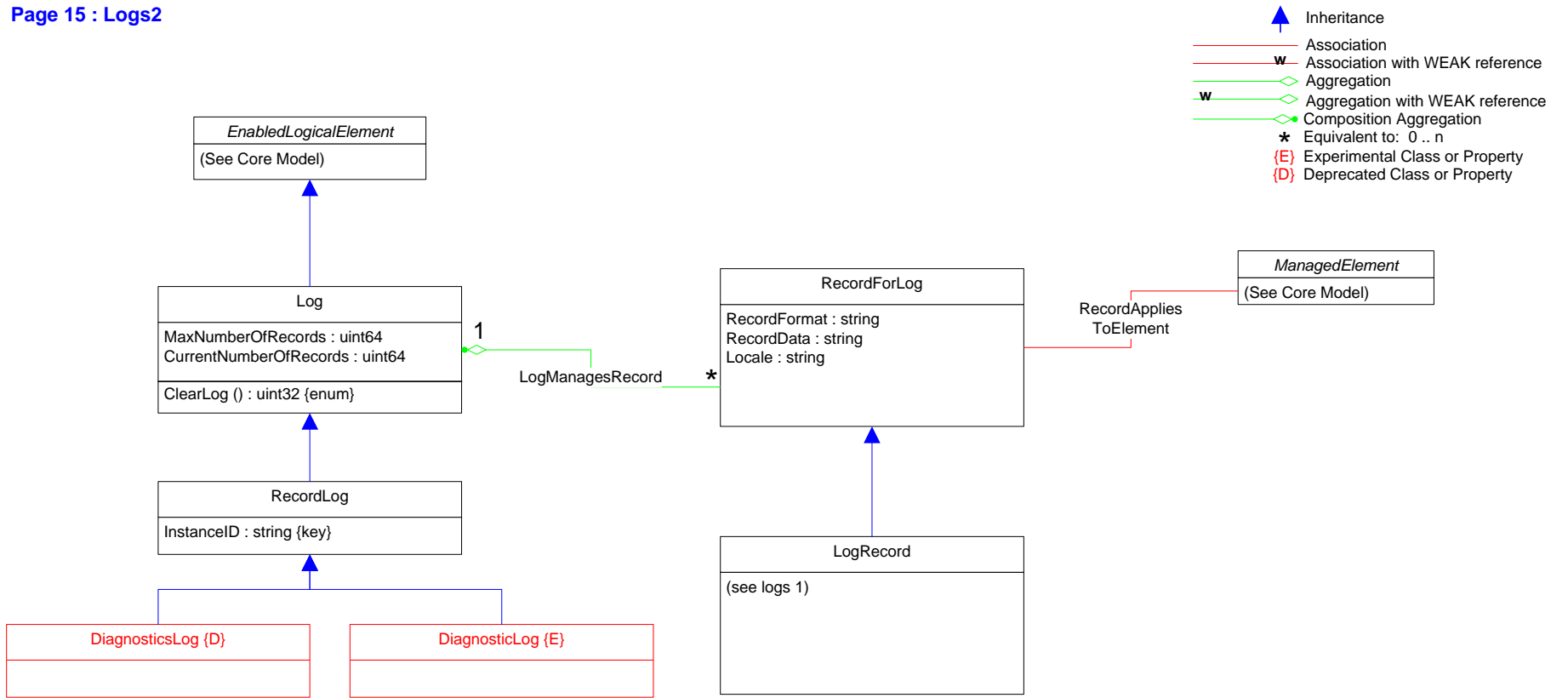

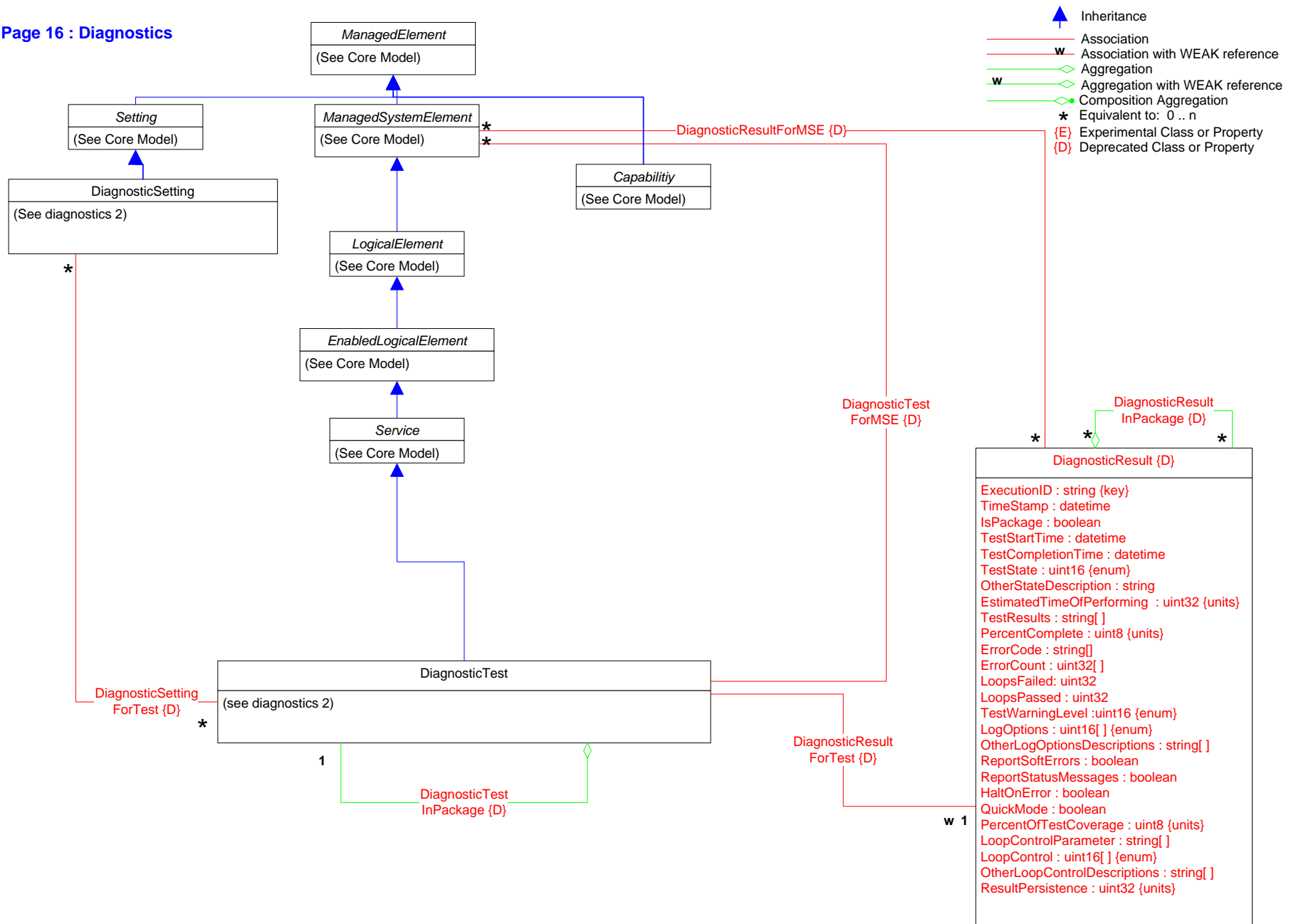

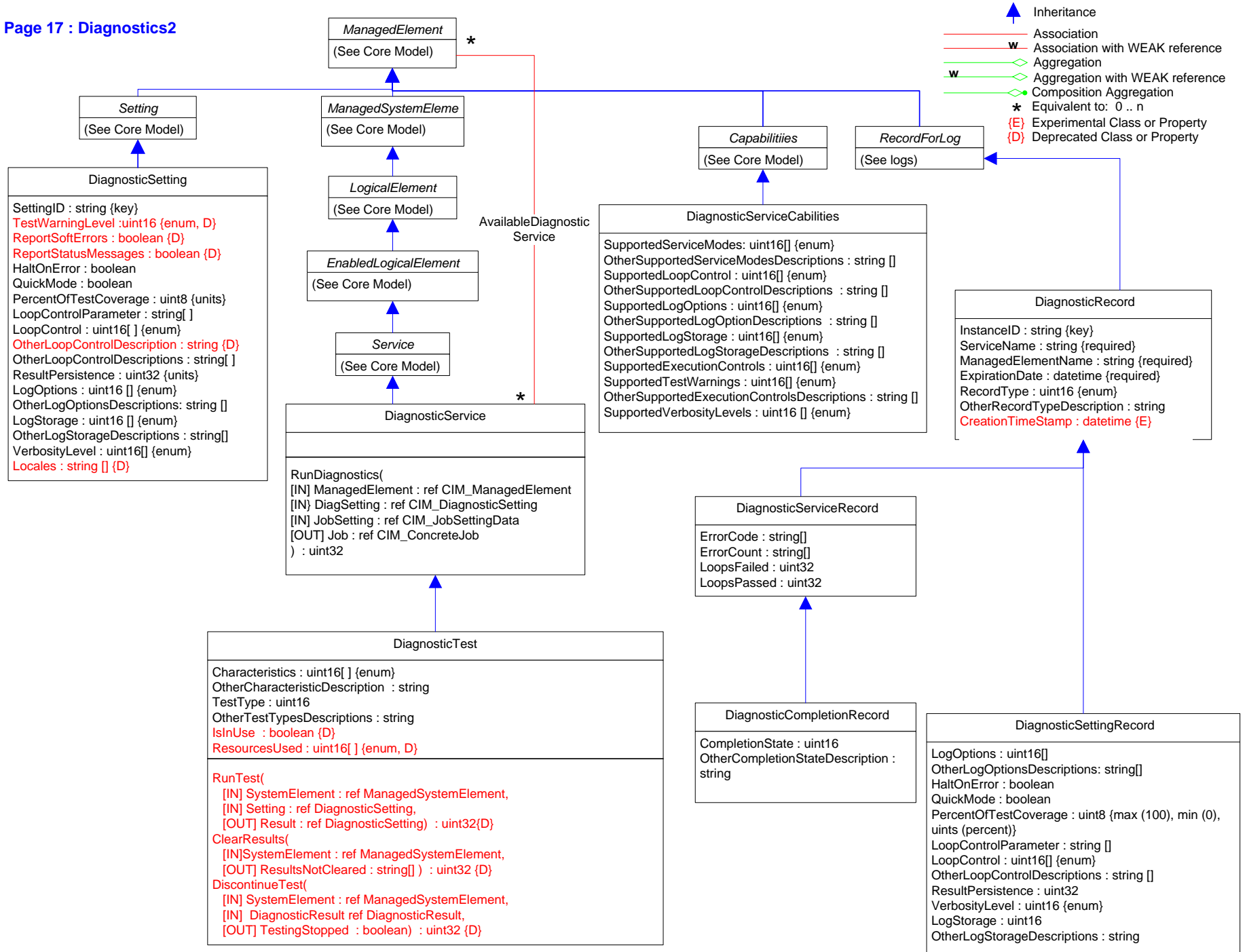

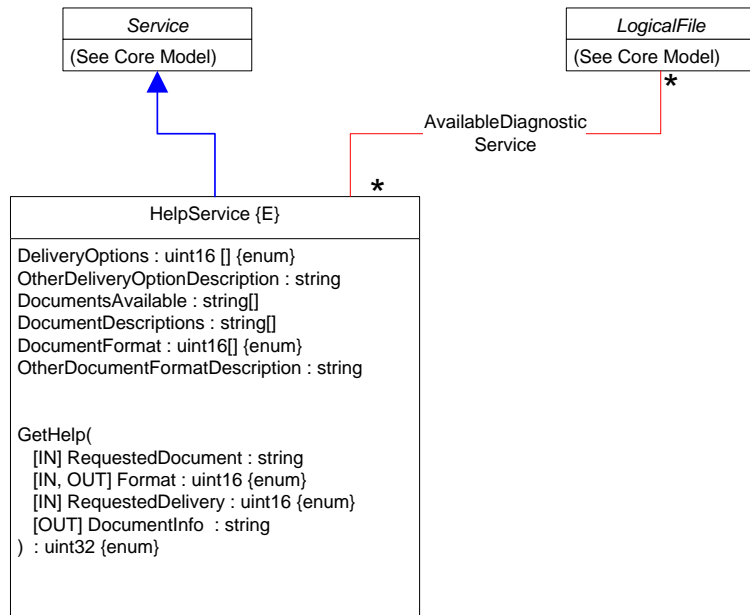

- Inheritance
- Association
- Association with WEAK reference
- Aggregation
- Aggregation with WEAK reference
- Composition Aggregation
- Equivalent to: 0 .. n
- Experimental Class or Property
- Deprecated Class or Property

Page 19 : Virtualization

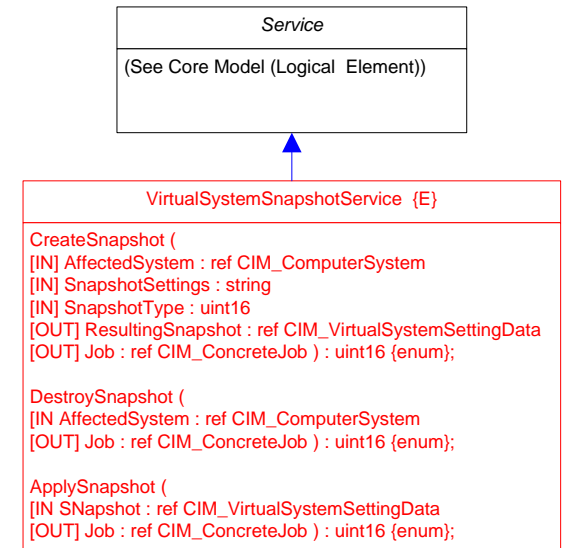
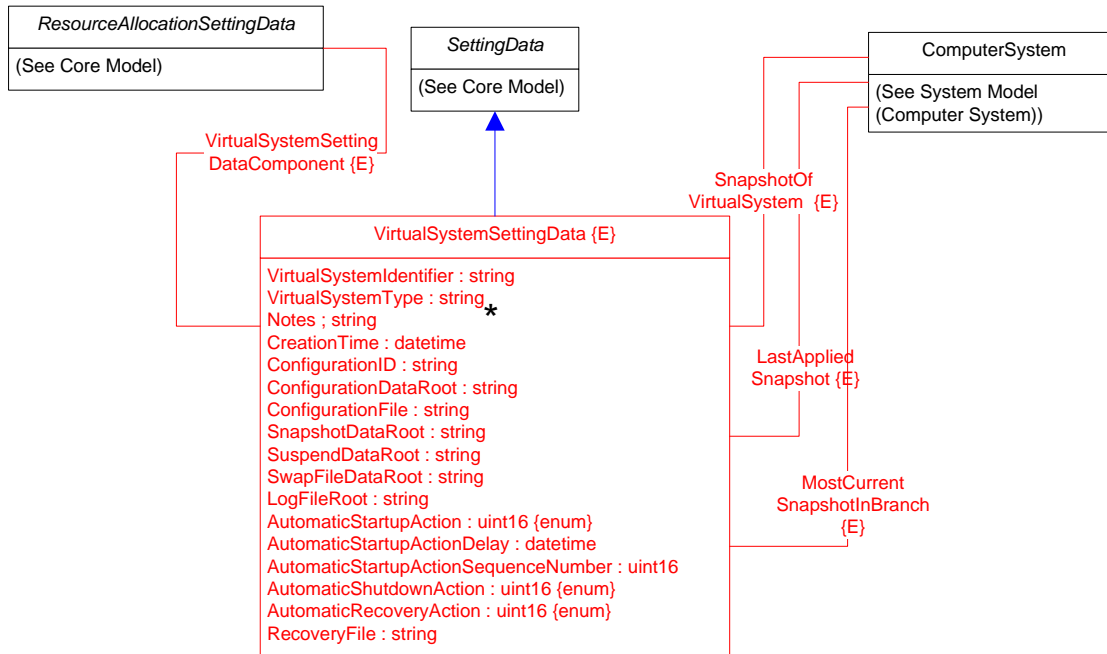
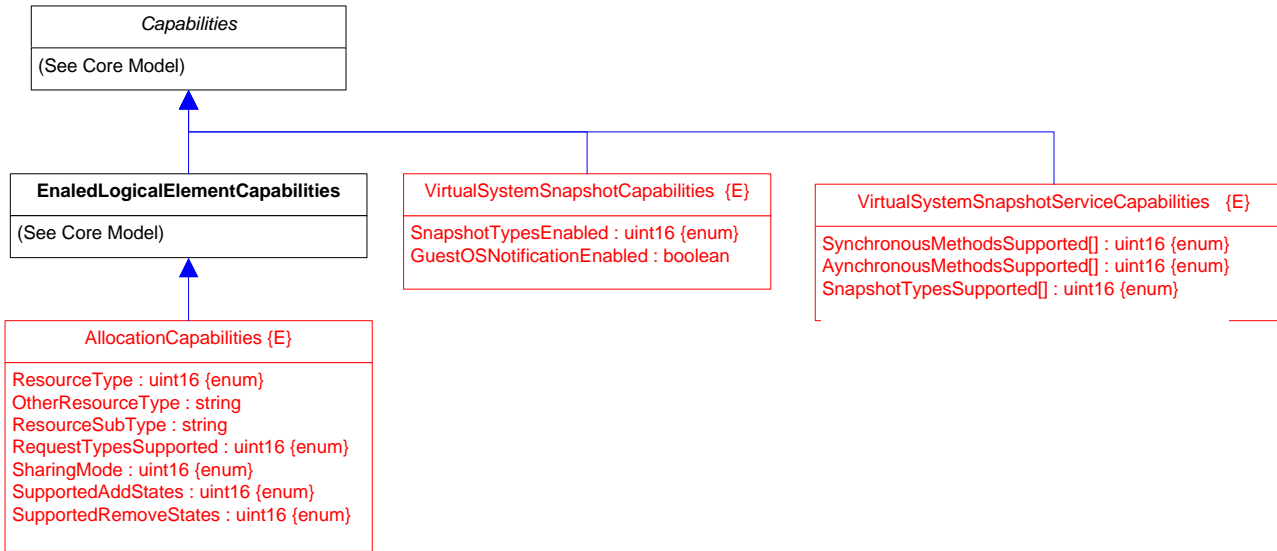
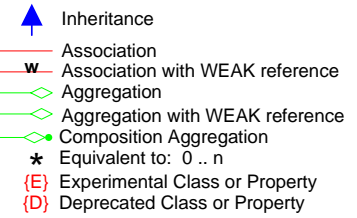

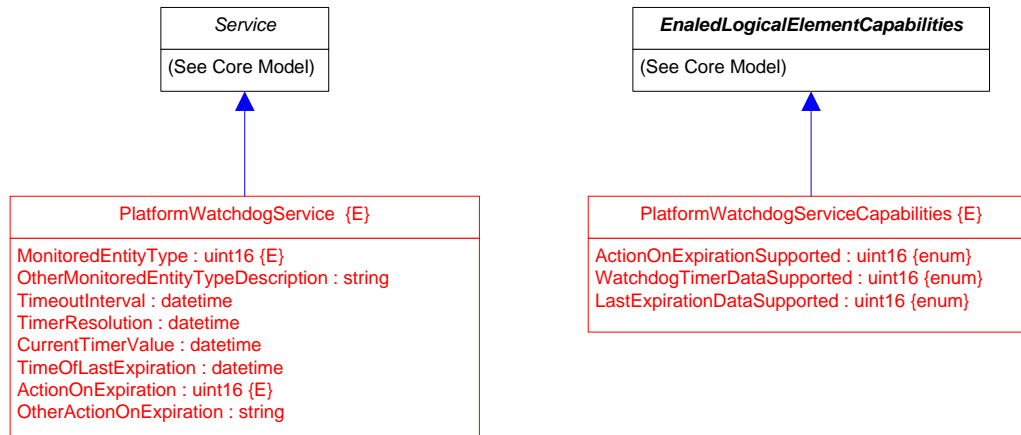
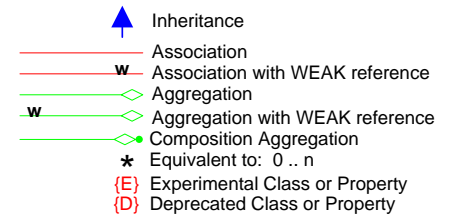

Page 21 : Association Hierarchy

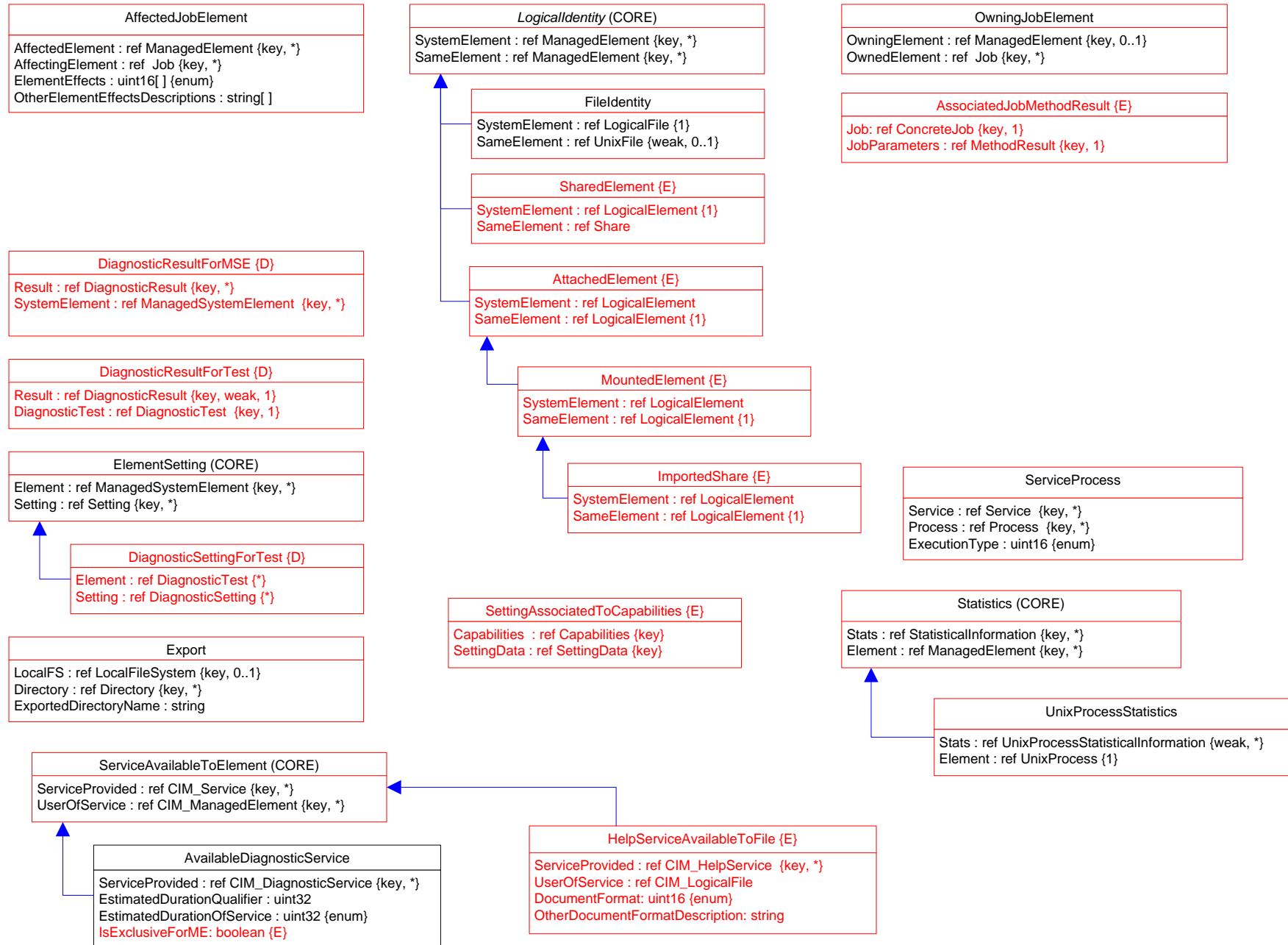

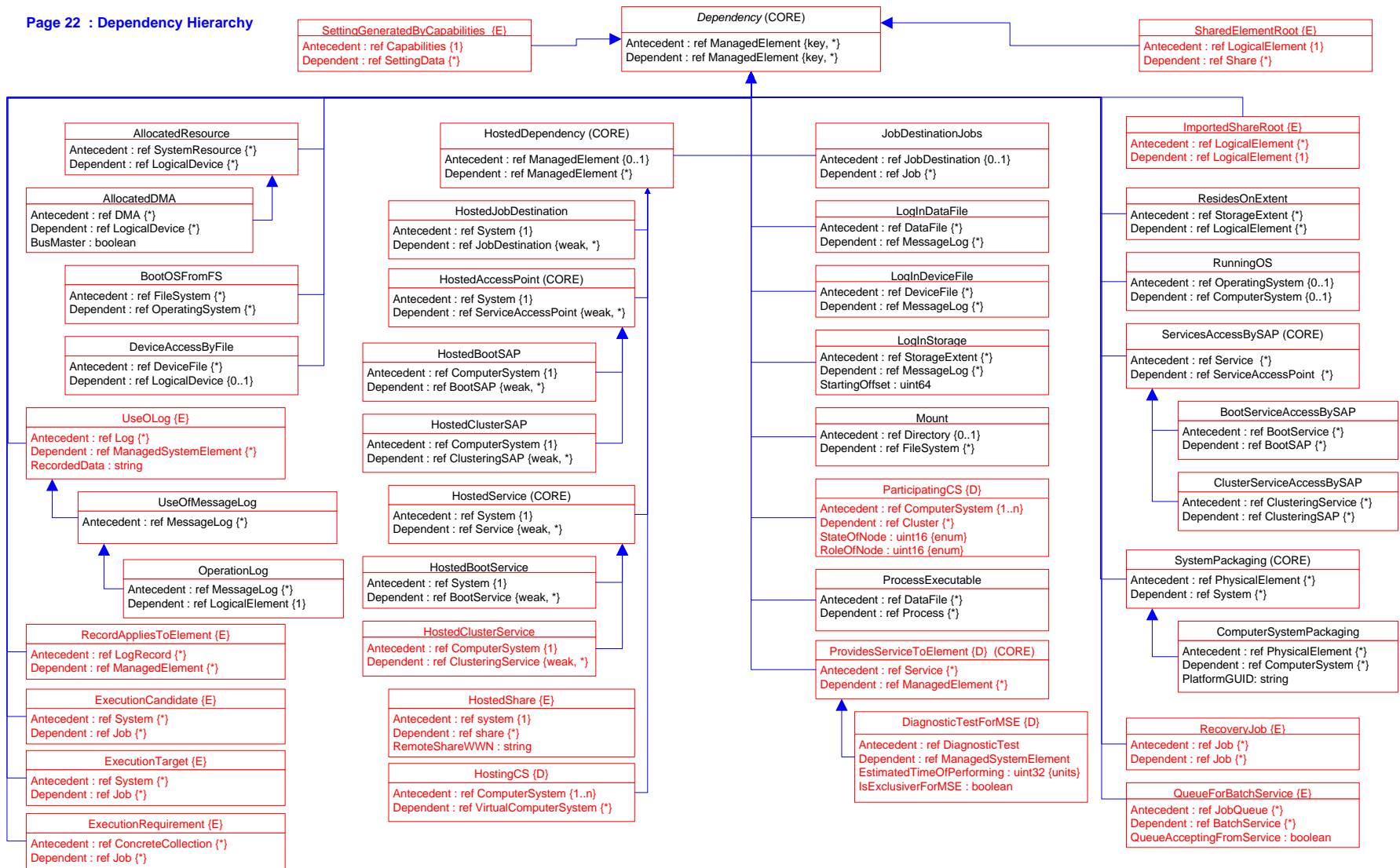

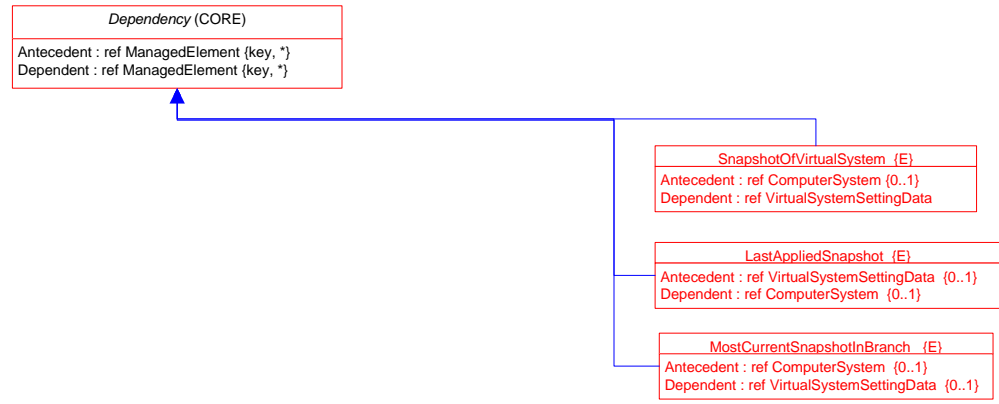

Page 22 : Aggregation Hierarchy

